

Cooker
ГОТВАРСКА ПЕЧКА

HKN 9430 E

Gebrauchsanleitung

Blomberg

Please read this manual first.

Dear Customer,

We would like you to obtain best performance with your product that has been manufactured in modern facilities and passed through strict quality control procedures.

Therefore, we advise you to read through this User Manual carefully before using your product and keep it for future reference. If you hand over the product to someone else, deliver the User Manual as well.

The User Manual will help you use the product in a fast and safe way.

- Read the User Manual before installing and starting the product.
- You must strictly observe the safety instructions.
- Keep this User Manual within easy reach for future reference.
- Also read other documents supplied with the product.
Remember that this User Manual may also be applicable for several other models.
Differences between models are explicitly identified in the manual.

Explanation of symbols

Throughout this User Manual the following symbols are used:

 Important information or useful hints about usage.

 Warning for hazardous situations with regard to life and property.

 Warning for electric shock.

 Warning for risk of fire.

 Warning for hot surfaces.



Arçelik A.Ş.

Karaağaç caddesi No:2-6
34445 Sütlüce/İstanbul/TURKEY

Made in TURKEY

Table of Contents

1 General information 4

Overview	4
Technical specifications	5
Accessories supplied with the unit	6

2 Safety instructions 8

General safety	8
Safety when working with electricity	9
Intended use	9
Safety for children	9

3 Installation 10

Before installation	10
Installation and connection	10
Disposal	12
Disposing of packaging material	12
Disposing of the old product	12
Future Transportation	13

4 Preparation 14

Tips for saving energy	14
Initial operation	14
Setting the time	15
First cleaning of the appliance	15
Initial heating	15

5 How to use the hob..... 17

General information on cooking.....	17
How to use hobs.....	17

6 How to operate the oven..... 19

General information on baking, roasting and grilling	19
How to use the electric oven	19
Operating modes.....	21
How to operate the oven control unit	24
How to use the program lock.....	26
How to use the alarm clock.....	26
Cooking times table.....	27
How to operate the grill	29
Cooking times table for grilling.....	30

7 Maintenance and care 31

General information	31
How to clean the hob.....	31
Cleaning the control panel.....	32
Cleaning the oven	32
Removal of oven door.....	33
Taking off the door inner glass	33
Replacing the oven lamp	34

8 Troubleshooting 35

1 General information

Overview

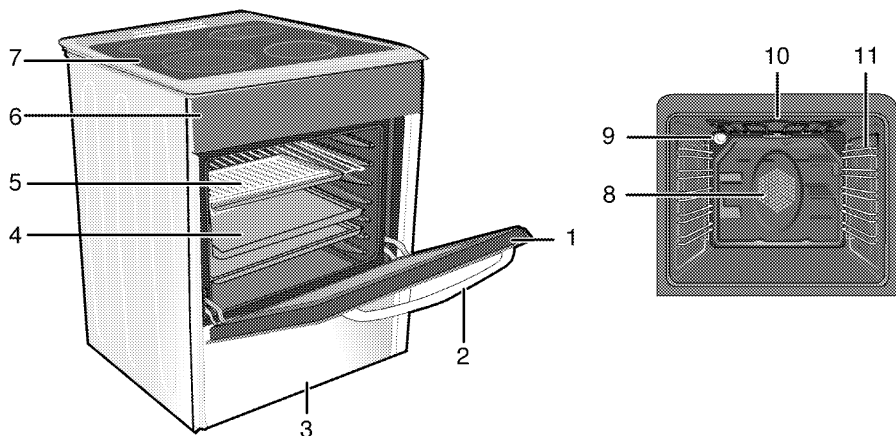

- 1 Front door
- 2 Handle
- 3 Bottom drawer
- 4 Tray
- 5 Wire shelf
- 6 Control panel

- 7 Burners' plate
- 8 Fan motor (behind steel plate)
- 9 Lamp
- 10 Grill heating element
- 11 Shelf positions

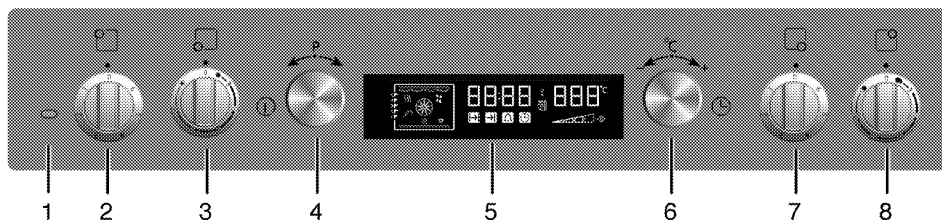

- 1 Warning lamp
- 2 Single-circuit cooking plate Rear left
- 3 Dual-circuit cooking plate Front left
- 4 On/Off program selection knob
- 5 Digital timer

- 6 Menu knob
- 7 Single-circuit cooking plate Front right
- 8 Extended cooking plate Rear right

Technical specifications

GENERAL	
External dimensions (height / width / depth)	850 mm/600 mm/600 mm
Voltage / frequency	220-240 V ~ 50 Hz
Total power consumption	10.6 kW
Fuse	min. 16 A x 3
Cable type / section	H05VV-FG 3 x 4 mm ²
Cable length	max. 2 m
HOB	
Burners	
Rear left	Single-circuit cooking plate
Dimension	140 mm
Power	1200 W
Front left	Dual-circuit cooking plate
Dimension	210/120 mm
Power	2200/750 W
Front right	Single-circuit cooking plate
Dimension	180 mm
Power	1700 W
Rear right	Extended cooking plate
Dimension	170/265 mm
Power	1500/2400 W
OVEN/GRILL	
Main oven	Multifunction oven
Energy efficiency class [#]	A
Inner lamp	15-25 W
Grill power consumption	2.2 kW

[#] Basics: Information on the energy label of electrical ovens is given in accordance with the EN 50304 standard. Those values are determined under standard load with bottom-top heater or fan assisted heating (if any) functions.

Energy efficiency class is determined in accordance with the following prioritization depending on whether the relevant functions exist on the product or not. 1-Cooking with eco-fan, 2- Turbo slow cooking, 3- Turbo cooking, 4- Fan assisted bottom/top heating, 5-Top and bottom heating.

** See. *Installation, page 10.*

 Technical specifications may be changed without prior notice to improve the quality of the product.

 Figures in this manual are schematic and may not exactly match your product.

i Values stated on the product labels or in the documentation accompanying it are obtained in laboratory conditions in accordance with relevant standards. Depending on operational and environmental conditions of the product, these values may vary.

Accessories supplied with the unit

i Accessories supplied can vary depending on the product model. All the accessories described in the user manual may not exist on your product.

Baking tray

Can be used for pastries, frozen foods and big roasts.

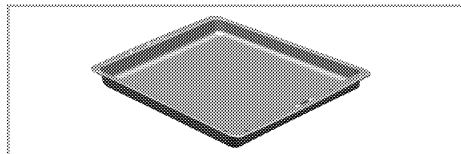

Deep roasting tray

Can be used for pastries, big roasts, foods with liquid content and during grilling as dripping pan.

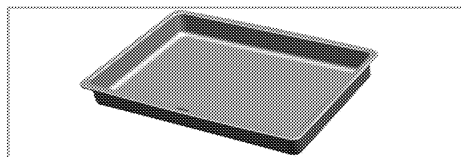

Pastry tray

It is recommended for pastries such as cookies and biscuits.

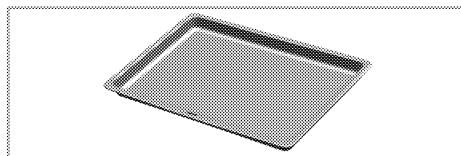

Small baking tray

Can be used for small portions. This baking tray is placed onto the wire shelf.

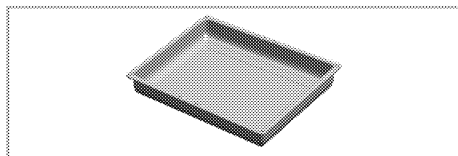

Wire shelf

Can be used for roasting and as deposit for baking, roasting and casserole dishes.

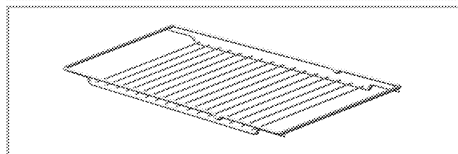
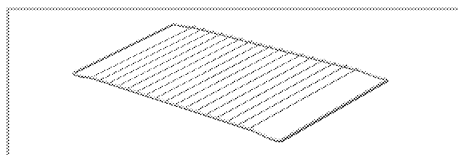

Proper positioning of the wire shelf and tray on sliding shelves

Trays and wire shelves used with the sliding shelf (model dependant) must be positioned correctly with the inner edges of the shelf placed over the pins on the sliding shelf. This holds the shelf firmly in place".

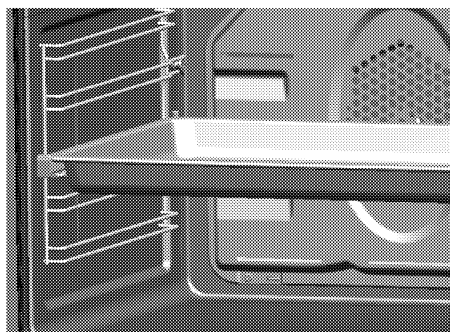

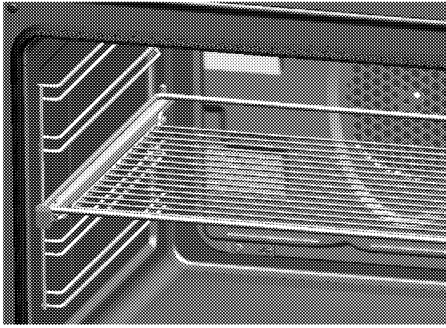

Turn spit function

Can be used for grilling meat, poultry and fish from all sides.

- Fix the food to be grilled to the turn spit with the forks.
- Put the turn spit frame into the oven at the level of the turn spit drive.
- Insert the turn spit into the drive and put it onto the turn spit frame.

- Take off the handle during grilling.

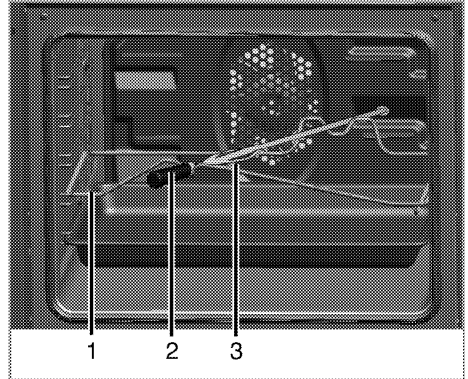

- 1 Spit frame
- 2 Plastic part
- 3 Fork

2 Safety instructions

General safety

- This product is not intended to be used by persons with physical, sensory or mental disorders or unlearned or inexperienced people (including children) unless they are attended by a person who will be responsible for their safety or who will instruct them accordingly for use of the product.
Children must be supervised to prevent them from tampering with the product.
- Connect the product to a grounded outlet/line protected by a fuse of suitable capacity as stated in the "Technical specifications" table. Have the grounding installation made by a qualified electrician while using the product with or without a transformer. Our company shall not be liable for any damages that will arise due to using the product without a grounding installation in accordance with the local regulations.
- Do not operate the product if the power cable or plug is damaged. Call Authorised Service Agent.
- Do not operate the product if it is defective or has any visible damage.
- Do not carry out any repairs or modifications on the product. However, you may remedy some troubles that do not require any repairs or modifications. See *Troubleshooting, page 35*.
- Never wash down the product with water! There is the risk of electric shock!
- Never use the product when your judgement or coordination is impaired by the use of alcohol and/or drugs.
- Product must be disconnected from the mains during installation, maintenance, cleaning and repair procedures.
- Installation and repair procedures must always be performed by Authorised Service Agents. Manufacturer shall not be held responsible for damages arising from procedures carried out by unauthorised persons.
- Be careful when using alcoholic drinks in your dishes. Alcohol evaporates at high temperatures and may cause fire since it can ignite when it comes into contact with hot surfaces.
- Do not heat closed tins and glass jars in the oven. The pressure that would build-up in the jar may cause it to burst out.
- Do not place any flammable materials close to the product as the sides become hot during use.
- Do not place baking trays, dishes or aluminium foil directly onto the bottom of the oven. The heat accumulation might damage the bottom of the oven.
- Keep all ventilation slots clear of obstructions.
- Product may be hot when it is in use. Never touch the hot burners,

inner sections of the oven, heaters and etc.

- Always use heat resistant oven gloves when putting and removing dishes into/from the hot oven.
- Do not use the product with front door glass removed or cracked.
- Rear surface of the oven gets hot when it is in use. Make sure that the gas/electrical connection do not contact the rear surface; otherwise, connections can get damaged.
- Do not trap the mains cable between the oven door and frame and do not route it over the hot surfaces. Otherwise, cable insulation may melt and cause fire as a result of short circuit.
- Make sure that the product is switched off after every use.
- Vapour pressure that build up due to the moisture on the hob surface or at the bottom of the pot can cause the pot to hop. Therefore, make sure that the oven surface and bottom of the pots are always dry.

 Product must be installed by a qualified person in accordance with the regulations in force. Otherwise, the warranty shall become void.

Safety when working with electricity

- Any work on electric equipment and systems may only be carried out by authorized qualified persons.
- In case of any damage, switch off the appliance and disconnect it

from the mains supply by removing the fuse or switching off the circuit breaker.

- Ensure that the fuse rating is correct.

Intended use

This product is designed for domestic use. Commercial use is not admissible. This product should not be used for warming the plates under the grill, drying towels, dish cloths and etc. by hanging them on the handles and for heating purposes.

The manufacturer shall not be liable for any damage caused by improper use or handling errors.

The oven can be used for defrosting, baking, roasting and grilling food.

Safety for children

- Accessible parts of the appliance will become hot whilst the appliance is in use and until the appliance has cooled, children should be kept away.
- "**CAUTION:** Accessible parts may be hot when the grill is in use. Young children should be kept away."
- Do not store any items above the appliance that children may reach.
- The packaging materials will be dangerous for children. Keep the packaging materials away from children. Please dispose of all parts of the packaging according to environmental standards.
- When the door is open, do **not** load any heavy object on it and do **not** allow children to sit on it. It may overturn or door hinges may get damaged.

3 Installation

Before installation

To ensure that critical air gaps are maintained under the appliance, we recommend that this appliance is mounted on a solid base and that the feet do not sink into any carpet or soft flooring.

The kitchen floor must be able to carry the weight of the appliance plus the additional weight of cookware and bakeware and food.

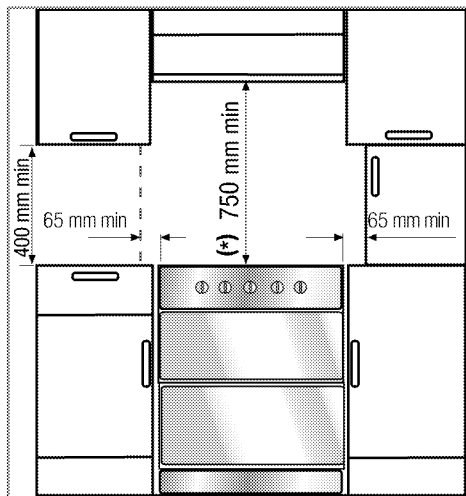

A safety distance must be left between the appliance and the kitchen walls and furniture. See figure (values in mm).

- It can be used with cabinets on either side but in order to have a minimum distance of 400 mm above hotplate level allow a side clearance of 65 mm between the appliance and any wall, partition or tall cupboard.
- It can also be used in a free standing position. Allow a

minimum distance of 750 mm above the hob surface.

- (*) If a cooker hood is to be installed above the cooker, refer to cooker hood manufacturer' instructions regarding installation height (Min 65cm).
- The appliance corresponds to device class 1, i.e. it may be placed with the rear and **one** side to kitchen walls, kitchen furniture or equipment of any size. The kitchen furniture or equipment on the **other** side may only be of the same size or smaller.
- Any kitchen furniture next to the appliance must be heat-resistant (100 °C min.).

Installation and connection

- ❗ Do not install the appliance next to refrigerators or freezers. The heat emitted by the appliance will lead to an increased energy consumption of cooling appliances.
- Appliance to be installed in accordance with the local authority requirements for gas, electricity and any other authority having jurisdiction.
- Carry the appliance with at least two persons.
- ❗ **Material damage!**
The door and/or handle must not be used for lifting or moving the appliance.

- The appliance must be placed directly on the floor. It must not be placed onto a base or a pedestal.

⚠ Risk of explosion by damage of the safety tube!

The safety tube must not be clamped, bent or trapped or come into contact with hot parts of the appliance.

Connection to the mains supply

i This appliance must be earthed!

Our company shall not be held responsible for any damage caused by using the appliance without earthed socket.

⚠ Risk of electric shock, short circuit or fire by unprofessional installation!

The appliance may be connected to the mains supply only by an authorized qualified person and the appliance is only guaranteed after correct installation.

⚠ Risk of electric shock, short circuit or fire by damage of the mains lead!

The mains lead must not be clamped, bent or trapped or come into contact with hot parts of the appliance. If the mains lead is damaged, it must be replaced by a qualified electrician.

The mains supply data must correspond to the data specified on the rating plate of the appliance. The rating plate is either seen when the door or the lower cover is opened or it is located at the rear wall of the

appliance depending on the appliance type.

The supply cable of the appliance must correspond to the specifications; see technical data table *Technical specifications, page 4*.

⚠ Risk of electric shock!

Before starting any work on the electrical installation, please disconnect the appliance from the mains supply.

1. If no all-pole separation from the mains supply is possible, a separation unit must be connected with a contact distance of 3 mm min. (fuses, line safety switches, contactors) all poles which should be adjacent to (but not above) the appliance in accordance with IEE regulations. Failure to observe this instruction may result in operational problems and invalidation of the appliance warranty.

Additional protection by a residual current circuit breaker is recommended.

If a mains lead without a plug is not supplied with the appliance;

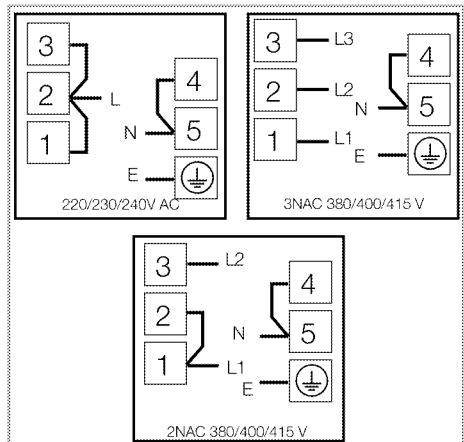

2. For single phase connection,

Take care to connect as below:

- Brown cable = L (Live)
- Blue cable = N (Neutral)
- Green/yellow cable must be connected to ground (E)  line.
- Position appliance up to the kitchen wall.
- To align the appliance with the worktop, adjust the feet turning right or left hand as required.

For equipment with a cooling fan

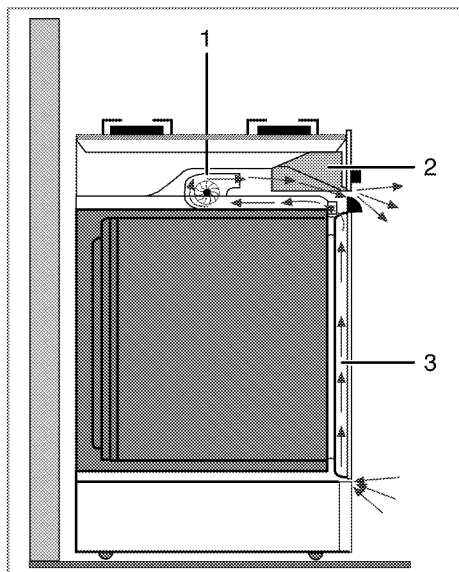

- 1 Fan
- 2 Control panel
- 3 Door

The cooling fan cools both the control panel and the front of the appliance.

-  Cooling fan continues to run for up to 20-30 minutes (approx.) even after the oven is turned off.

Final check

1. Switch electricity supply on.

2. Check electrical functions.

Disposal

Disposing of packaging material

Packaging materials are dangerous to children. Keep packaging materials in a safe place out of reach of children. Packaging materials of the product are manufactured from recyclable materials. Dispose of them properly and sort in accordance with recycled waste instructions. Do not dispose of them with normal domestic waste.



Disposing of the old product



Dispose of the old product in an environmentally friendly manner. This equipment bears the selective sorting symbol for waste electrical and electronic equipment (WEEE). This means that this equipment must be handled pursuant to European Directive 2002/96/EC in order to be recycled or dismantled to minimize its impact on the environment. For further information, please contact local or regional authorities.

Electronic equipments not included in the selective sorting process are potentially dangerous for the environment and human health due to the presence of hazardous substances. Refer to your local dealer or solid waste collection centre in your area to learn how to dispose of your product. Before disposing of the product, cut off the power cable plug and make the door lock (if any) unusable to avoid dangerous conditions to children.

Future Transportation

- Keep the product's original carton and transport the product in it. Follow the instructions on the carton. If you do not have the original carton, pack the product in bubble wrap or thick cardboard and tape it securely.
 - To prevent the wire grill and tray inside the oven from damaging the oven door, place a strip of cardboard onto the inside of the oven door that lines up with the position of the trays. Tape the oven door to the side walls.
- Do not use the door or handle to lift or move the product.
 -  Do not place other items on the top of the appliance. The appliance must be transported upright.
 -  Check the general appearance of your product for any damages that might have occurred during transportation.

4 Preparation

Tips for saving energy

The following information will help you to use your appliance in an ecological way, and to save energy:

- Use dark coloured or enamel coated cookware in the oven since the heat transmission will be better.
- While cooking your dishes, perform a preheating operation if it is advised in the user manual or cooking instructions.
- Do not open the door of the oven frequently during cooking.
- Try to cook more than one dish in the oven at the same time whenever possible. You can cook by placing two cooking vessels onto the wire grill.
- Cook more than one dish one after another. The oven will already be hot.
- You can save energy by switching off your oven a few minutes before the end of the cooking time. Do not open the oven door.
- Defrost frozen dishes before cooking them.
- Use pots/pans with cover for cooking. If there is no cover, energy consumption may increase 4 times.
- Select the burner which is suitable for the bottom size of the pot to be used. Always select the correct pot size for your dishes. Larger pots require more energy.
- Pay attention to use flat bottom pots when cooking with electric hobs.

Pots with thick bottom will provide a better heat conduction. You can obtain energy savings up to 1/3.

- Vessels and pots must be compatible with the cooking zones. Bottom of the vessels or pots must not be smaller than the hotplate.
- Keep the cooking zones and bottom of the pots clean. Dirt will decrease the heat conduction between the cooking zone and bottom of the pot.
- For long cookings, turn off the cooking zone 5 or 10 minutes before the end of cooking time. You can obtain energy savings up to 20% by using the residual heat.

Initial operation

Before first usage of your appliance, don't forget to remove the sticker on the digital timer screen

Setting the time

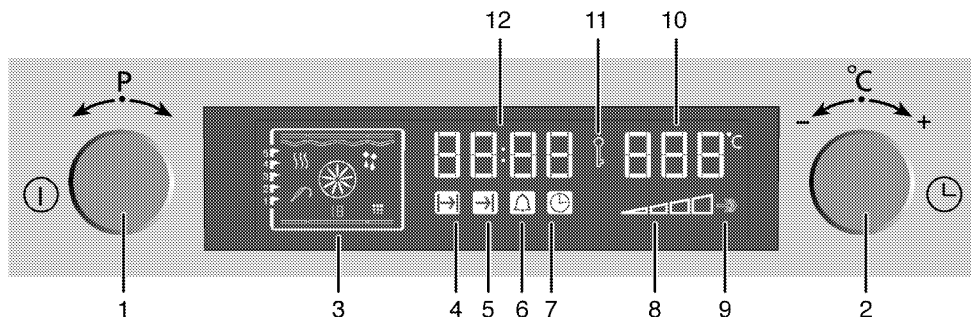

- 1 On/Off program selection knob
- 2 Menu knob
- 3 Function display
- 4 Cooking time symbol
- 5 Cooking end time symbol
- 6 Alarm period symbol
- 7 Current time symbol
- 8 Inner oven temperature symbol
- 9 Booster position
- 10 Temperature display
- 11 Keylock symbol
- 12 Current time display

1. After switching on the oven for the first time, adjust the time of the day by slightly twisting the button **2** towards + or -.

 If the current time is not set, time setting will start increasing up from **12:00**. Clock icon '7' will remain lit to indicate that the current time has not been set. This icon will disappear once the time is set.

Adjust the existing time

1. Activate the time of the day symbol '7' by pressing the button **2** twice for the time of the day.

2. Adjust the time of the day by slightly twisting the button **2** towards + or -.

 Current time settings are cancelled in case of power failure. It needs to be readjusted. Time of the day can not be changed if the oven is operating in a function.

First cleaning of the appliance

 The surface may get damaged by some detergents or cleaning materials. Do not use aggressive detergents, cleaning powder/cream or any sharp objects.

1. Remove all packaging materials.
2. Wipe the surfaces of the appliance with a damp cloth or sponge and dry with a cloth.

Initial heating

Heat up the product for about 30 minutes and then switch it off. Thus, any production residues or layers will be burnt off and removed.

-  Hot surfaces may cause burns!
Do not touch the hot surfaces of the appliance. Use oven gloves.
Keep children away from the appliance.

Electric oven

1. Take all baking trays and the wire grill out of the oven.
2. Close the oven door.
3. Select Static position.
4. Select the highest grill power; See *How to use the electric oven, page 19*.
5. Operate the oven about 30 minutes.

6. Turn off your oven; See *How to use the electric oven, page 19*

Grill oven

1. Take all baking trays and the wire grill out of the oven.
2. Close the oven door.
3. Select the highest grill power; see *How to operate the grill, page 29*.
4. Operate the oven about 30 minutes.
5. Turn off your grill; see *How to operate the grill, page 29*

-  Smell and smoke may emit during first heating. Ensure that the room is well ventilated.

5 How to use the hob

General information on cooking

- ⚠ Risk of fire by overheated oil!
When you heat oil, do not leave it unattended.

Never try to extinguish the fire with water! When oil has caught fire, immediately cover the pot or pan with a lid. Switch off the hob if safe to do so and phone the fire service.

- Ensure handles of pans cannot accidentally be caught or knocked and do not get hot by adjacent heating zones. Avoid pans that are unstable and easily tipped. Pans that are too heavy to move easily when filled can also be a hazard. Only use flat bottomed pots or pans.
- Use pans which have sufficient capacity for the amount of food being cooked so they don't boil over and cause unnecessary cleaning.
Do not place lids on the burners. Always position pans centrally over the burners. When transferring pans from one burner to another always lift the pans do not slide them.

Tips for glass ceramic hobs

- The glass ceramic surface is heat-resistant and insensitive to large temperature deviations.
- Do not use the glass ceramic hob for keeping objects or as cutting surface.

- Use pot and pans with ground bottoms. Sharp edges cause scratches on the surface.
- Do not use aluminium pots and pans. Aluminium damages the glass ceramic surface.

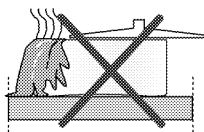

Splashes may damage the ceramic surface and can cause fire.

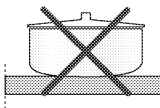

Do not use pots that have concave or convex bottoms.

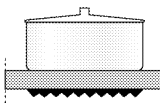

Use pot and pans with smooth bottoms. They ensure a good heat transfer.

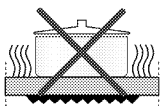

If the pan is too small energy is wasted

How to use hobs

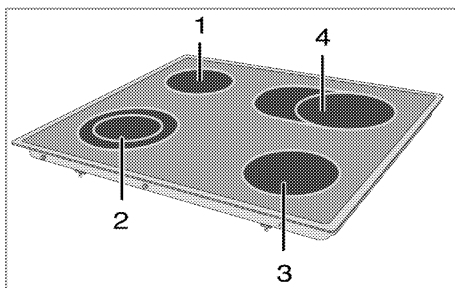

- 1 Single-circuit cooking plate 14-16 cm
- 2 Dual-circuit cooking plate 21-23/12-14 cm
- 3 Single-circuit cooking plate 18-20 cm

- 4 Extended cooking plate 17-19/26-28 cm is list of advised diameter of pots to be used on related burners.

⚠ Broken glass!

Do not let any objects fall onto the hob. Even small objects (e.g. salt shaker) may damage the hob.

Do not use glass ceramic hobs with cracks. Water may enter into the cracks and cause a short circuit.

If the surface is damaged in any way (e. g. visible cracks), switch off the device immediately to reduce the risk of an electric shock.

- ⓘ Quick heating glass-ceramic hobs emit a bright light when they are switched on. Do not stare to bright light.**

Switching the plate on

The hob control knobs are used for operating the plates. To obtain the desired cooking power, turn the hob control knobs to the corresponding level.

Cooking level	1	2 – 3	4 – 6
	warming	stewing, simmering	cooking, roasting

Cooking level	1	2	3
	warming	stewing, simmering	cooking, roasting

Switching the plate off

Turn hob control knob to off position (top).

How to operate on the multiple zone hotplates

Hobs with multiple region are used for different diameter of pans. It is a standard; the inner zone will be activated when the hob is switched on.

1. By changing the knob position in clockwise direction, the diameter of active zone can be adjusted.
2. While the diameter of active zone changes, there will be a "click" noise.

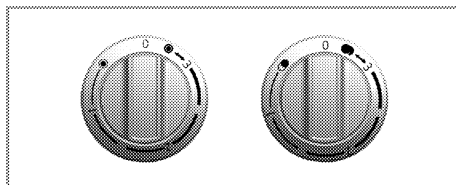

Switch off multiple zone hotplates

1. In order to turn off the hob, set the knob to "0" position by turning it in a counterclockwise direction. Both cooking zones are switched off.

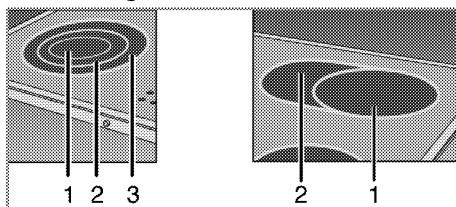

- 1 Stage 1
- 2 Stage 2
- 3 Stage 3

- ⓘ The 2nd or 3rd zones of multiple zone hotplates will not operate by themselves.**

6 How to operate the oven

General information on baking, roasting and grilling

- ⚠ Risk of scalding by hot steam!
Take care when opening the oven door as steam may escape.

Tips for baking

- Use non-stick coated appropriate metal plates or aluminum containers or heat-resistant silicone moulds.
- Make best use of the space on the rack.
- It is recommended to place the baking mould in the middle of the rack.
- Select the correct shelf position before turning the oven or grill on - don't move oven shelves when hot.
- Keep the oven door closed.

Tips for roasting

- Seasoning with lemon juice and black pepper will improve the cooking performance when cooking a whole chicken, turkey or a large piece of meat.
- Meat with bones takes about 15 to 30 minutes longer before it is cooked than a roast of the same size without bones.
- You should calculate about 4 to 5 minutes cooking time per centimeter height of the meat.
- Let meat rest in the oven for about 10 minutes after the cooking time. The juice is better distributed all over the roast and does not run out when the meat is cut.

- Fish in a fire-resistant dish should be placed on the rack at the medium or lower level.

Tips for grilling

Grilling is ideal for cooking meat, fish and poultry and will achieve a nice brown surface without it drying out too much. Flat pieces, meat skewers and sausages are particularly suited for grilling as are vegetables with a high water content such as tomatoes and onions.

- Distribute the pieces to be grilled on the wire shelf.
- If the grilling is on the wire shelf, locate a dripping pan under it in order to collect the fat.
- Add some water in the dripping pan for easy cleaning.

How to use the electric oven

Turning the oven on

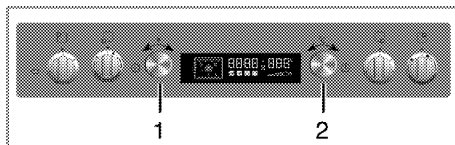

- 1 On/Off program selection knob
- 2 Menu knob

1. Press button **1** for about 1 second to turn the oven on.

Select temperature and operating mode

After turning the oven on; nothing appears at the function display.



i Oven will switch off automatically within 10 seconds if no oven setting is made on this screen.

Temperature, cooking time, cooking end time and booster can be set in this position.

1. Slightly turn the button no. **1** to left or right so that the desired function;
2. You can adjust the desired temperature by slightly twisting the button **2** towards + and -.

» Your oven will readily start operating in the desired function and will increase the inner temperature to the set temperature.

» Active heaters and suggested tray position appear on the function display.



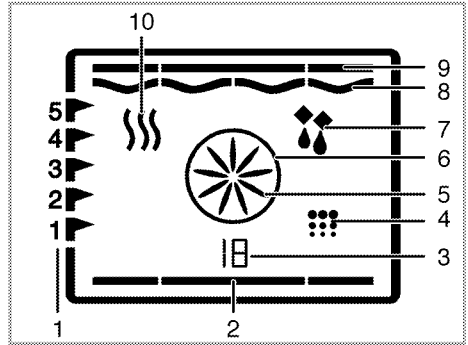

» If no temperature setting is made previously, then the suggested temperature for the selected function is indicated on the temperature display. Function table contains the functions that can be used as well as minimum and maximum temperatures that can be selected in the oven.



- 1 Shelf position
 - 2 Bottom heater
 - 3 Function number
 - 4 Cleaning position
 - 5 Turbo fan
 - 6 Turbo heater
 - 7 Defrost position
 - 8 Grill heater
 - 9 Upper heater
 - 10 Warm keeping
- * Functions can vary depending on the product model!

Function table :

Function	Suggested temperature (°C)	Temperature range (°C)
Static	200	40-280
Static + fan	175	40-280
Fan heating	180	40-280
3 D	205	40-280
Pizza	210	40-280
Grill	280	40-280
Low grill	280	40-280
Slow cooking	180	160-220
Bottom heater	180	40-220
Warm keeping	60	40-100

-  Maximum time that can be set for cooking period is limited with 6 hours at positions apart from keeping warm due to safety reasons. In case of power cut, program will be canceled. Reprogram is needed.
-  While making any adjustment, related symbols on the clock will flash.
-  Time of the day can not be adjusted when the oven is operating in any function or the clock is set to a semi-automatic or full automatic program.
-  Even if the oven is off, oven lamp lights up when the oven door is opened.

Switch off electric oven

Press button **1** for about 2 seconds to turn the oven off.

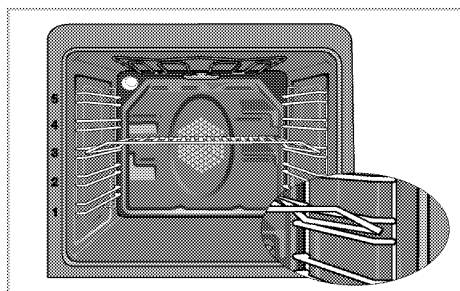

Shelf positions (model dependant)

It is important to position the wire grill on wire shelf correctly. The wire grill must be placed so that it will fit into the opening of the wire shelf as illustrated in the figure.

Operating modes

The order of operating modes shown here might deviate from the arrangement on your appliance.

1. Top and bottom heat

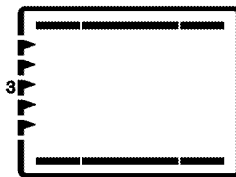

The foodstuffs are heated simultaneously from the upper and lower part. Suitable e.g. for cakes, cookies and casseroles in baking moulds. Cook with one tray only.

2. Top and bottom heat with convection air



Warm air heated by the lower and upper heaters is evenly distributed throughout the oven very fast by means of the fan. Cook with one tray only.

3. Hot air

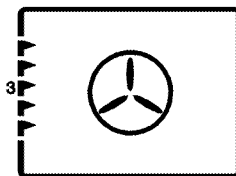

Warm air heated by the rear heater is evenly distributed throughout the oven very fast by means of the fan. It is suitable for cooking your meals in different shelf levels and preheating is not required in most cases. Suitable for cooking with multi trays.

4. "3D" function

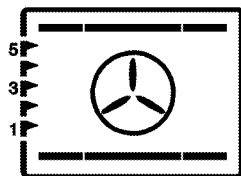

Top heat, bottom heat plus ring heat with fan (in the rear wall) are on. The appliance to be cooked is evenly and quickly cooked all around. Cook with one tray only.

5. Pizza function



The bottom heat and the heating ring with fan (in the rear wall) are in operation. Suitable for baking pizza.

6. Strong grill with convection air



Warm air heated by the large grill is distributed very fast in the oven by means of the fan. It is suitable for grilling large amount of meat.

- Put big or medium-sized portions in correct shelf position under the grill heater for grilling.
- Set the temperature to maximum level.
- Turn the food after half of the grilling time.

7. Surface grill

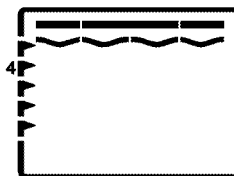

The large grill (under the oven roof) is in operation. Suitable for grilling larger quantities.

- Put big or medium-sized portions in correct shelf position under the grill heater for grilling.
- Set the temperature to maximum level.
- Turn the food after half of the grilling time.

8. Grill-small

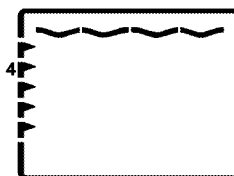

The grill (under the oven roof) is in operation. Suitable for grilling.

- Put small or medium-sized portions in correct shelf position under the grill heater for grilling.
- Set the temperature to maximum level.
- Turn the food after half of the grilling time.

9. Slow cooking

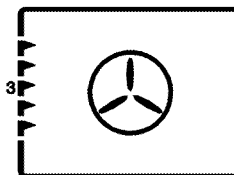

To save power, you can use this function instead of the cooking operations that you would perform by using turbo cooking at 160-220°C temperature range. But, the cooking time will increase a little bit.

Cooking times for this mode is given 'Slow cooking' table.

10. Bottom heat



Only bottom heat is on. Is particularly suitable for dishes, such as pizza, which are required to be baked from bottom.

11. Warm keeping

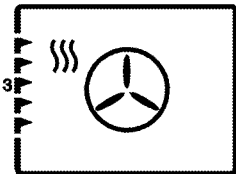

Can be used for keeping food warm at low temperature and over a longer period of time.

12. Operating with fan



The oven is not heated. Only the fan (in the rear wall) is in operation. Frozen granular food is thawed slowly at room temperature and cooked food is cooled down.

13. Pyrolytic cleaning - eco mode

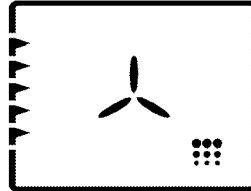

This function allows the oven to clean itself at a high temperature. It is recommended for lightly soiled ovens. Read the description in the cleaning section to use this function.

14. Pyrolytic cleaning

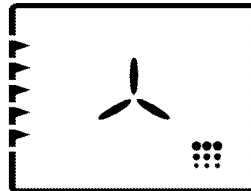

This function allows the oven to clean itself at a high temperature. Read the description in the cleaning section to use this function.

 When the oven door is opened, the fan motor will not run to keep the hot air inside.

How to operate the oven control unit

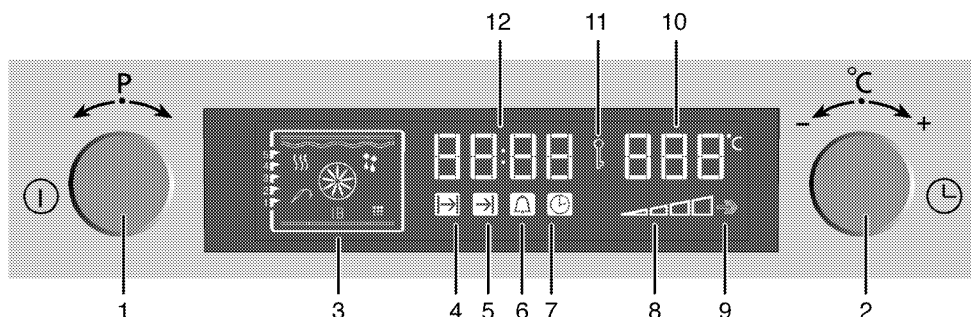

- 1 On/Off program selection knob
- 2 Menu knob
- 3 Function display
- 4 Cooking time symbol
- 5 Cooking end time symbol
- 6 Alarm period symbol
- 7 Current time symbol
- 8 Inner oven temperature symbol
- 9 Booster position
- 10 Temperature display
- 11 Keylock symbol
- 12 Current time display

Switch on semi-automatic operation

In this operation mode, you may adjust the time period during which the oven will operate (cooking time). Oven starts to operate after the settings are made and runs at the set temperature throughout the cooking time. Oven turns off at the end of the cooking time.

1. Turn on the oven by pressing and holding button '1'.
2. Adjust the desired operation mode (function) by slightly twisting the button '1' towards right or left hand.
3. Activate the cooking time symbol '4' by pressing the button '2' with while the oven is operating.
4. Adjust the cooking time by slightly twisting the button 2 towards "+" or "-".

- » Cooking time symbol '4' remains lit after adjusting the cooking time.
- 5. Place your dish in the oven.
- 6. Adjust the cooking temperature by slightly twisting the button 2 towards "+" or "-".
- » The oven will be heated up to the preset temperature and will maintain this temperature until the end of the cooking time you selected.

i All segments of the inner oven temperature symbol (8) will turn on when your oven reaches the set temperature.

7. After the cooking process is completed, "End" will be displayed and the alarm signal will sound.
8. To stop the alarm signal, press button no. '1' or '2'.
 - » Alarm will be silenced, oven will be turned off automatically and current time will be displayed on the screen.

Switch on automatic operation

In this operation mode you may adjust how long the oven will be operate (cooking time) and when it will be turned off (cooking end time).

1. Turn on the oven by pressing and holding button '1'.

2. Adjust the desired operation mode (function) by slightly twisting the button '1' towards right or left hand.
3. Activate the cooking time symbol '4' by pressing the button '2' while the oven is operating.
4. Adjust the cooking time by slightly twisting the button 2 towards "+" or "-".

» Cooking time symbol 4 remains lit after adjusting the cooking time.

5. Activate the cooking end time symbol (5) by pressing the button 2 with short intervals.
6. Adjust the cooking end time by slightly twisting the button '2' towards "+" or "-".

» Cooking end time symbol (5) remains lit after adjusting the cooking end time.

7. Place your dish in the oven.
8. Adjust the cooking temperature by slightly twisting the button 2 towards "+" or "-".

» Oven timer automatically calculates the startup time for cooking by using the end of cooking time you have set and the cooking period. Selected operation mode is activated when the startup time of cooking has come and the oven is heated up to the set temperature. It maintains this temperature until the end of the cooking time. Oven lamp lights up during cooking.

 All segments of the inner oven temperature symbol (8) will turn on when your oven reaches the set temperature.

9. After the cooking process is completed, "End" will be displayed and the alarm signal will sound.

10. To stop the alarm signal, press button no. '1' or '2'.

» Alarm will be silenced, oven will be turned off automatically and current time will be displayed on the screen. Oven lamp will also switch off.

 If you want to cancel the semi-automatic or automatic programming after you have set them, you need to reset the cooking time.

Setting the Booster (Quick Preheating)

It can be used to reach to the desired inner oven temperature more quickly by operating the oven heaters in a combination different than the selected function.

 Booster function can only be set while the oven is operating. Booster function can not be selected in defrosting and cleaning modes. Booster setting is cancelled in case of power failure.

1. For booster function, press button 2 with short intervals until the booster symbol '9' becomes active.

» "OFF" will be displayed.

2. Activate the booster by slightly twisting the button 2 towards "+".

» After the booster is adjusted, "On" will be displayed and the booster symbol will remain lit.

» Booster symbol turns off after the desired inner oven temperature is attained and oven resumes its operation with the function selected before the booster.

3. To cancel the booster function, press button **2** to activate the booster symbol (**9**).
 - » **"On"** will be displayed.
4. Deactivate the booster by slightly twisting the button **2** towards **"-"**.
 - » **"OFF"** will be displayed.

How to use the program lock

Activate the program lock

You can prevent using of oven by activating the keylock feature.

 Keylock can be used either the oven is operating or not operating. Oven can still be turned off by keeping the button **1** pressed for 2 seconds even the key lock is activated while the oven is operating.

1. For keylock; press button **'2'** with short intervals until the keylock symbol **"11"** becomes active.
 - » **"OFF"** will be displayed.
2. Activate the keylock by slightly twisting the button **'2'** towards **"+"**.

» After the keylock is adjusted, **"On"** will be displayed and the keylock symbol will remain lit.

Deactivate the program lock

1. To deactivate the keylock, press button **'2'** with short intervals until the keylock symbol **"11"** becomes active.
 - » **"On"** will be displayed.
2. Deactivate the keylock by slightly twisting the button **2** towards **"-"**.
 - » After the keylock is turned off, **"OFF"** is displayed and the keylock symbol **'11'** disappears.

 Oven buttons can not be used while the keylock function is active. Keylock function is not cancelled in a power failure.

How to use the alarm clock

In addition to using the timer for cooking, it can be also used as a reminder or an alarm clock.

As soon as the defined period of time has expired, the alarm clock will emit a signal. The alarm clock has no influence on the functions of the oven.

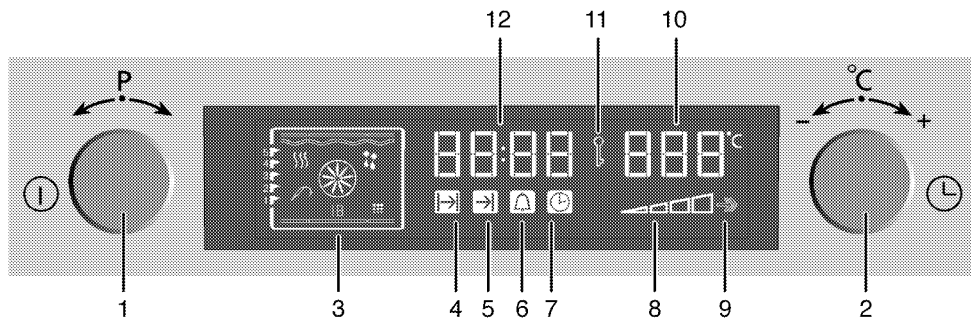



- | | | | |
|---|-------------------------------|----|-------------------------------|
| 1 | On/Off program selection knob | 7 | Current time symbol |
| 2 | Menu knob | 8 | Inner oven temperature symbol |
| 3 | Function display | 9 | Booster position |
| 4 | Cooking time symbol | 10 | Temperature display |
| 5 | Cooking end time symbol | 11 | Keylock symbol |
| 6 | Alarm period symbol | 12 | Current time display |

Using the clock as an alarm

Alarm clock does not have any effect on the oven functions. It is used as a warning.

For example, you can use alarm clock to warn you for turning the dish in the oven round in a certain time.

 The maximum alarm time can be 23 hours and 59 minutes.

 Alarm clock can be used either the oven is operating or not operating.

Setting the alarm clock

1. Press button '2' with short intervals until the alarm symbol '6' becomes active.

2. Adjust it by slightly twisting the button 2 towards "+" or "-".

» Alarm symbol remains lit after adjusting the alarm time.

3. After the alarm time is finished, alarm symbol will start flashing and an alarm signal is heard.

4. You can stop the alarm by pressing any button.

In order to cancel set alarm time;

1. To reset the alarm time, press button '2' to activate the alarm symbol (6).



















2. Adjust it by slightly twisting the button '2' towards "-" until "00:00" is displayed.











Cooking times table

 The values indicated in the table below are data indicative. They may vary according to the type of food as well as your preferences of cooking.

Baking and roasting

 Level 1 is the **bottom** level in the oven.

Food	Cooking level number		Rack position	Temperature (°C)	Cooking time (min.) (approx.)
Cake in tray*	One level		4	175	30 ... 35
Cake in mould*	One level		2	180	40 ... 50
Cakes in paper*	One level		3	175	25 ... 30
	2 levels		1 - 5	175	30 ... 40
	3 levels		1 - 3 - 5	180	45 ... 55
Sponge cake*	One level		3	200	5 ... 10
	2 levels		1 - 5	175	18 ... 25
Cookies*	One level		3	175	20 ... 25
	2 levels		1 - 5	175	25 ... 30
	3 levels		1 - 3 - 5	175	30 ... 40
Dough pastry*	One level		2	200	30 ... 40
	2 levels		1 - 5	200	45 ... 55
	3 levels		1 - 3 - 5	200	55 ... 65
Filled savory pastry*	One level		2	200	25 ... 35
	2 levels		1 - 5	200	30 ... 40
	3 levels		1 - 3 - 5	190	40 ... 50
Leaven*	One level		2	200	35 ... 45
	2 levels		1 - 3	200	35 ... 45











Food	Cooking level number		Rack position	Temperature (°C)	Cooking time (min.) (approx.)
Lasagne*	One level		2 - 3	200	30 ... 40
Pizza*	One level		2	200 ... 220	15 ... 20
	One level		3	200	10 ... 15
Beefsteak (whole)/ Roast	One level		3	25 min. 250/max after 180 ... 190	100 ... 120
Lamb haunch (casserole)	One level		3	25 min. 250/max after 190	70 ... 90
Roast chicken	One level		2	15 min. 250/max after 180 ... 190	65 ... 70
	One level		2	15 min. 250/max after 180 ... 190	55 ... 65
Turkey (5.5 kg)	One level		2	25 min. 250/max after 180 ... 190	150 ... 210
	One level		2	25 min. 250/max after 180 ... 190	150 ... 210
Fish	One level		3	200	20 ... 30
	One level		3	200	20 ... 30

While cooking with 2 trays at the same time, place the deep tray to the upper shelf and shallow tray to the lower shelf.

* It is suggested to perform preheating for all foods.

(**) In a cooking that requires preheating, preheat at the beginning of cooking until the temperature symbol (8) of the oven rises up to the highest level.

Slow cooking

Food	Cooking level number		Rack position	Temperature (°C)	Cooking time (min.) (approx.)
Meat-Casserole	One level		3	160	100 ... 120
Chicken-Casserole	One level		3	160	70 ... 100
Haricot Bean	One level		3	160	130 ... 150
Eggplant-Casserole	One level		3	160	130 ... 150
Steak - Whole	One level		3	160	110 ... 130
Steak - Sliced	One level		3	160	100 ... 120
Cakes in paper	One level		3	185	35 ... 40
Cookies	One level		3	185	30 ... 35
Dough pastry	One level		3	200	40 ... 45
Filled savory pastry	One level		3	200	40 ... 45

- Perform a preheating for 6-7 minutes.
- White/red meats have to be flipped over in the pan prior to cooking until boiled down.
- Haricot beans have to be boiled for 30 minutes prior to cooking. You may directly use canned bean.
- Covering the cooking pan will increase performance of cooking.

Tips for baking cakes

1. If pastry is too dry,

» Increase the temperature by 10°C and reduce the cooking time.

2. If pastry dropped,

- » Use less liquid or lower the temperature by 10°C.
- 3. If pastry is too dark on top,
 - » Place it on a lower rack, lower temperature, and increase the cooking time.
- 4. If cooked well on the inside but sticky on the outside,
 - » Use less liquid, lower the temperature, and increase the cooking time.

Tips for baking pastry

1. If the pastry is too dry,
 - » Increase the temperature some 10°C and decrease the cooking time.
 - » Dampen the layers of dough with a sauce composed of milk, oil, egg and yoghurt.
2. If the pastry takes too long to bake,
 - » Pay care that the thickness of the pastry you have prepared does not exceed the depth of the tray and remain level with it.
3. If the upper side of the pastry gets browned, but the lower part is not cooked,
 - » Make sure that the amount of sauce you have used for the pastry is not too much at the bottom of the pastry. Try to scatter the sauce equally between and on the dough layers for an even browning.
 - » Cook the pastry in accordance with the mode and temperature given in the cooking table. If the bottom part is still not browned enough, place it on a lower shelf next time.

Tips for cooking vegetables

1. If the vegetable dish runs out of juice and gets to dry,
 - » Sth in using a lid during cooking will keep the juice of the dish in the pan,

- cook your vegetable dishes in a pan with a lid instead of a tray.
2. If a vegetable dish does not get cooked,
 - » Boil the vegetables beforehand or prepare them like canned food and put in the oven.

How to operate the grill

-  Hot surfaces may cause burns!
Close oven door during grilling.

Switch on grill

1. Set the function knob onto the grill symbol.
2. Set grill temperature.
3. Preheat for approximately 5 minutes, if it is necessary.
 - » The thermostat lamp is switched on.

Switch off grill

1. Turn grill control knob to off position (top).

Switch on grill

1. Press button **1** for about 1 second to turn the oven on.
2. Adjust the grill function by slightly twisting the button '**1**' towards right or left hand.
3. You can adjust the desired temperature by slightly twisting the button **2** towards + and -.

Switch off grill

1. Press button **1** for about 2 seconds to turn the oven off.

Shelf positions

For optimum grill coverage, position the wire shelf towards the front of the oven just out of contact with the glass door. Placing the wire shelf fully to the rear of the oven will reduce the grill coverage.

Turn spit function

When grill function is selected, turnspit motor will start turning.

- Locate a dripping pan through the bottom in order to collect the fats. Add some water in dripping pan for easy cleaning.
- Fix the food to be grilled to the turn spit with the forks (3).
- Place the spit on the frame (1). Slide turn spit frame into the oven at the desired level.
- Insert the skewer to the hole which is connected to the turnspit motor on the rear wall of the oven cavity.
- **Do not forget to remove plastic part from spit (2).**
- After grilling, screw the plastic handle (2) to the skewer and take out the food from oven.

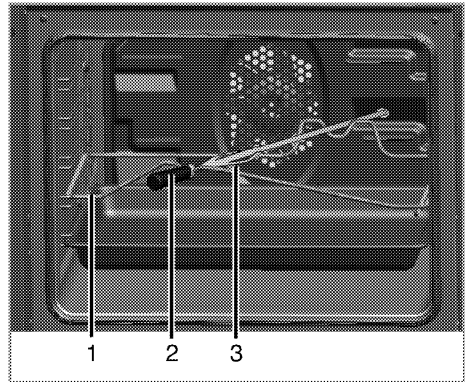

- 1 Spit frame
- 2 Plastic part
- 3 Fork

Cooking times table for grilling



Grilling with electric grill

Food	Insertion level	Grilling time (approx.)
Fish	4...5	20...25 min. #
Sliced chicken	4...5	25...35 min.
Lamb chops	4...5	20...25 min.
Roast beef	4...5	25...30 min. #
Veal chops	4...5	25...30 min. #
Toast bread	4	1...2 min.

depending on thickness

7 Maintenance and care

General information

-  Risk of electric shock!
Switch off the electricity before cleaning appliance to avoid an electric shock.
-  Hot surfaces may cause burns!
Allow the appliance to cool down before you clean it.
-  The surface may get damaged by some detergents or cleaning materials.
Do not use aggressive detergents, cleaning powder/cream or any sharp objects.

Clean the appliance thoroughly after each use; in this way it will be possible to remove cooking residues more easily, thus avoiding these from burning the next time the appliance is used.

No special cleaning agents are required for cleaning the appliance. It is recommended to use warm water with washing liquid, a soft cloth or sponge and use a dry cloth for drying.

Do not use any abrasive cleaning materials!

-  Do not use steam cleaners for cleaning.

How to clean the hob

Ceramic hobs

Always rinse off fully with a clean cloth wrung out in clean water (as residue could damage the ceramic glass surface next time the hob is used).

In no case should crusts be scratched off with serrated edge knives, steel wool or the like.

Remove calcium stains (yellow staining) with small amounts of decalcifying agents such as Durgol, vinegar or lemon juice.

Apply agent with a sponge and, in the event of heavier soiling, let it work in for a longer period of time. Afterwards, wash offhob with water.

-  Sugar-based food such as custard and syrup should immediately be scraped off without waiting for the surface to cool down. Otherwise the hob may be permanently damaged.

Cleaning the control panel

- i** Damage of the control panel!
Do not remove the control knobs for control panel cleaning.

Clean control panel and control knobs.

Cleaning the oven

No oven cleaner or any other special cleaning agent is required for cleaning the oven. It is recommended to wipe the oven with a damp cloth while it is still warm.

To clean the side wall,

1. Remove the front section of the side rack by pulling it in the opposite direction of the side wall.
2. Remove the side rack completely by pulling it towards you.

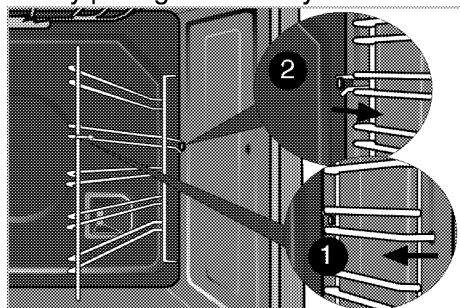

Pyrolytic self-cleaning

- ⚠** Hot surfaces may cause burns!
Do not touch the equipment and keep children away from the equipment during self-cleaning. Wait at least 30 minutes before removing residues.

The oven is equipped with pyrolytic self-cleaning. The oven is heated to approx. 480 °C and existing dirt is burned to ashes. A strong smoke development may arise. Provide for good ventilation. The pyrolysis should be used after approx. every 10th oven usage.

1. Remove all accessories from the oven. In models with side rack; do not forget to take out the side racks.
2. Before the cleaning cycle, remove dirt from exterior surfaces and oven interior with a damp cloth.

- i** Do not clean the door sealing. The fibre glass sealing is very sensitive and can be damaged easily.

In case of a damage on the oven door gasket, replace with the new one from the authorized service.

1. "Pyrolysis" **☼☼☼** Select the pyrolytic function (self-cleaning).

☼☼☼eco It is advised to use economic cleaning function if the oven does not have too much dirt.

If this function is used for heavy dirt, there won't be sufficient cleaning. For such cases, pyrolysis function **☼☼☼** should be applied after economic cleaning **☼☼☼eco** cycle finished.

- » The self-cleaning time appears in the display. This duration can not be adjusted.
- » The end of self cleaning cycle can be adjusted.

- i** The health of some birds is extremely sensitive to the fumes given off during the Self-Cleaning cycle. Always move birds to another closed and well ventilated room. Keep the kitchen well-ventilated during the Self-Cleaning cycle.

1. Oven door cannot be opened and lock symbol **🔒** appears on the time display during self cleaning. It remains locked for a while after the pyrolysis function ends. Do not

force the door lock with handle until

lock symbol  disappears.

2. After a clean cycle, remove soil deposits with vinegar water.

Clean oven door

Don't use any harsh abrasive cleaners or sharp metal scrapers for cleaning the oven door. They could scratch the surface and destroy the glass.

Removal of oven door

1. Open the front door.
2. Open the clips at the hinge housing on the right and left hand sides of the front door by pressing them down as illustrated in the figure.

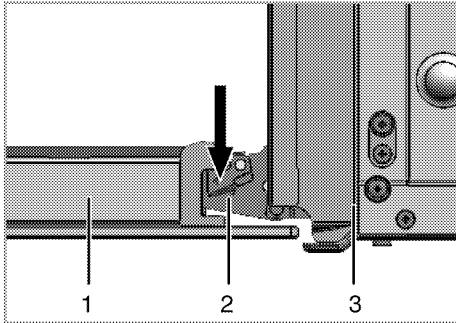

- 1 Front door
- 2 Hinge
- 3 Oven

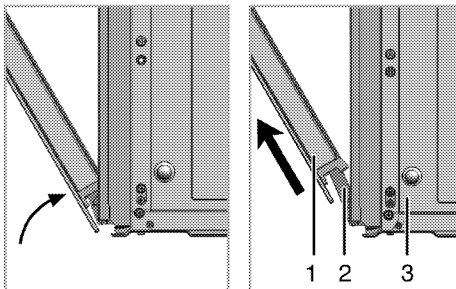

3. Move the front door to half-way.
4. Remove the front door by pulling it upwards to release it from the right and left hinges.

-  Steps carried out during removing process should be performed in reverse order (steps 4, 3, 2 and 1) to reattach the door. Do not forget to close the clips at the hinge housing when reinstalling the door.

Taking off the door inner glass

The inner glass panel of the oven door can be removed for cleaning.

1. Open oven door.

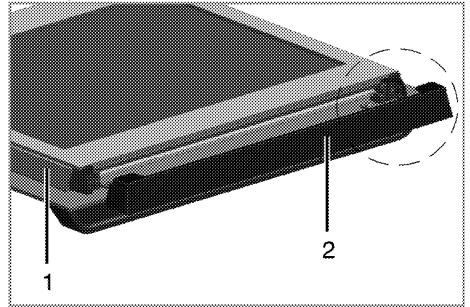

- 1 Frame
- 2 Plastic part

Remove the plastic part mounted upper side of the door by pulling towards yourself.

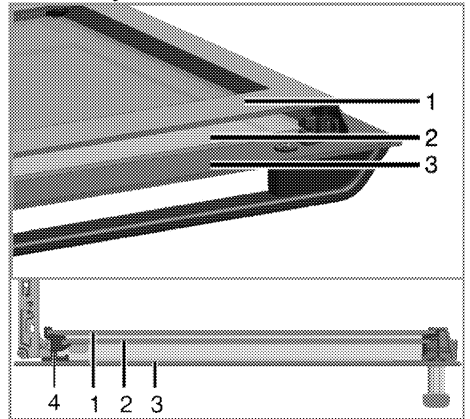

- 1 Inmost glass
- 2 Inner glass
- 3 Outer glass
- 4 Plastic housing for glass-bottom

As shown in the figure, lift the inmost glass slightly in 'A' direction. Then remove the glass by pulling in 'B' direction.

Repeat this operation to remove the inner glass.

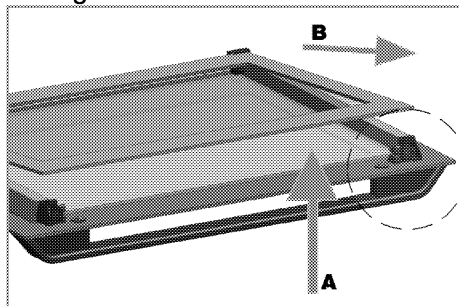

First step of reassembling the door is to mount the inner glass.

Chamfered corner of the glass should overlap the chamfer on the plastic housing as shown.

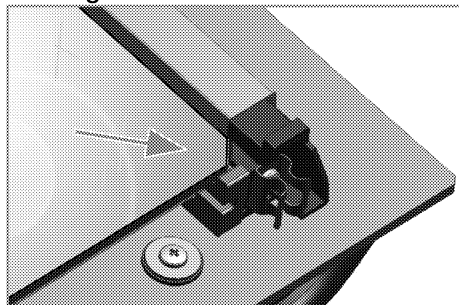

The inner glass should be mounted into the plastic housing nearer to the inmost glass.

While mounting the inmost glass, take great care that the printed surface faces the inner glass.

It is important in mounting inner glass to position the bottom corners of glass into bottom plastic housings properly. Push the plastic part against to the frame until you hear the “click” noise.

Replacing the oven lamp

⚠ Hot surfaces may cause burns!
Make sure that the appliance is switched off and cooled down in order to avoid the risk of an electrical shock.

The oven lamp is a special heat-resisting (T 300 °C) electric light bulb; see *Technical specifications, page 4*. Oven lamps can be obtained from a good local electrical store.

i Position of lamp may vary from diagram.

1. Switch off the appliance at the mains.
2. Unscrew glass cover by turning anti-clockwise.

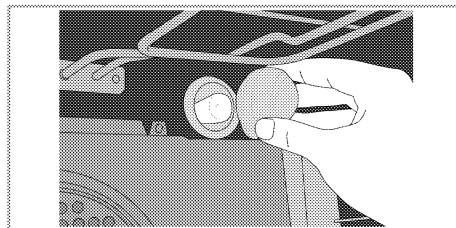

3. Take out the oven lamp by pulling out and replace with new one.
4. Refit the glass cover.

8 Troubleshooting

-  Risk of electric shock, short circuit or fire by unprofessional repairs!
Repairs on the appliance must be carried out by an approved service centre.

- It is normal that steam escapes during operation.
- When the metal parts are heated, they may expand and cause noise.

Before you call the service, please check the following points.

Normal operating conditions

- Smoke and smell may emit for a couple of hours during the first operation.

Electrical equipment

Malfunction/problem	Possible cause	Advice/remedy
The appliance does not work.	The mains fuse is defective or has tripped.	Check fuses in the fuse box. If necessary, replace or reset them.
	Timer buttons do not work.	Keylock may be enabled. Please disable it(See; <i>How to use the program lock, page 26</i>).
Oven light does not work	Oven lamp is defective.	Replace oven lamp.
	No current.	Check fuses in the fuse box. If necessary, replace or reset them.
Oven does not heat.	Function knob and/thermostat knob are not set.	Set function knob and thermostat knob.
	If the appliance has a timer, the timer may not be set.	Set the time.
	No power.	Check mains supply and fuse box.

If the problem has not been solved:

1. Separate unit from the mains supply (deactivate or unscrew fuse).
2. Call the after-sales service of your store reseller.

-  Do not attempt to repair the appliance yourself. There are no customer service items inside the appliance.